

**Compliance Guide  
02/2021**

# **Chain saws (electric mains powered and battery powered)**

European Garden Machinery Federation  
EGMF  
Bd Reyers 80, 1030 Brussels, Belgium  
[secretariat@egmf.org](mailto:secretariat@egmf.org)  
+32 2 206 68 66

# 1. Introduction

## Electric chain saw in conformity with EN 62841-1:2015 & EN 62841-4-1:2020

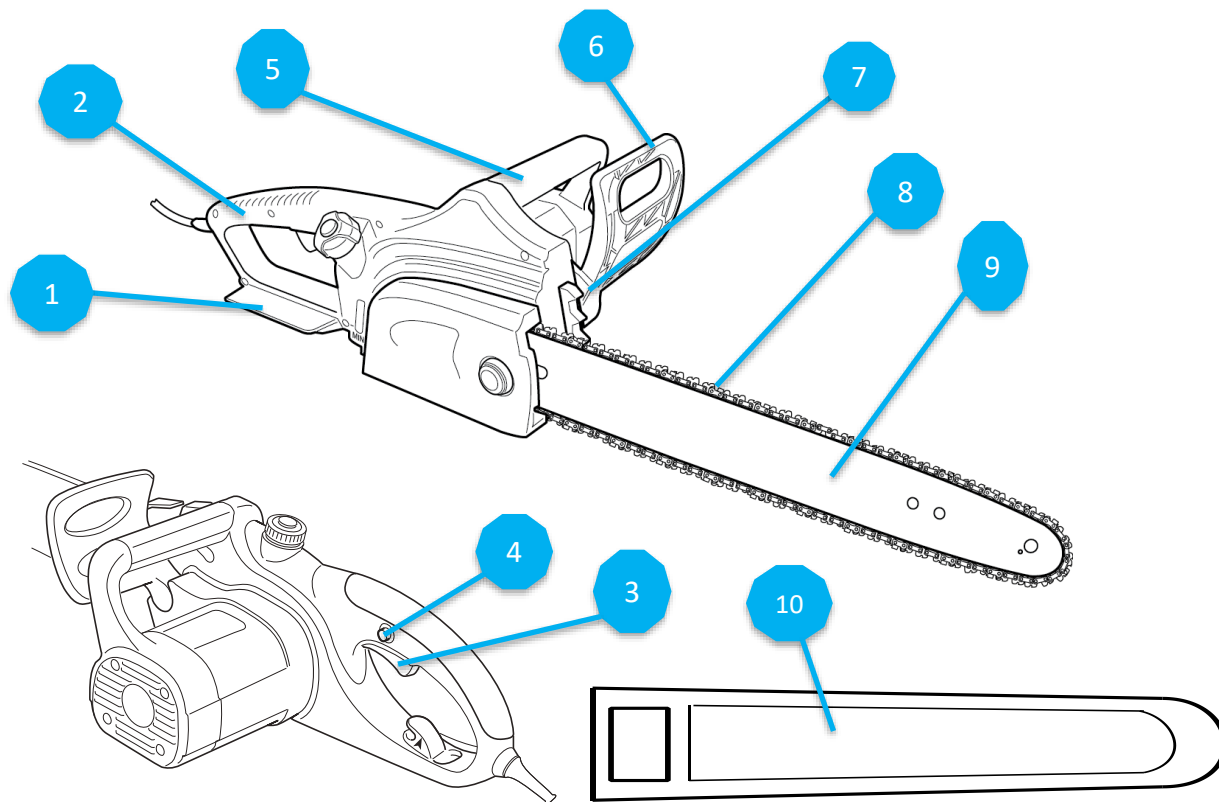

**Portable, electrically powered, hand-held chain saw**

### Key

- 1) rear hand guard
- 2) rear handle
- 3) power switch
- 4) switch lock-off
- 5) front handle
- 6) front hand guard
- 7) spiked bumper
- 8) saw chain
- 9) guide bar
- 10) guide bar cover

### Note:

1. The standards indicated in this guide are the latest published versions.
2. The inspection of a product should be conducted using **ONLY** the standards as declared by the manufacturer in the D.o.C. delivered with the product.

# 1. Introduction

Main EU technical Directives to be applied to electric chain saws

**Directive 2006/42/EC**  
Machinery

**Directive 2011/65/EU**  
**RoHS**  
(as amended)  
Restriction of Hazardous  
Substances

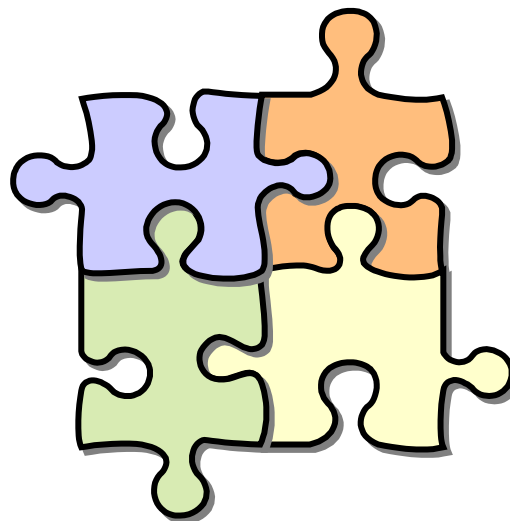

**Directive 2000/14/EC (as amended)**  
Outdoor Noise

**Directive 2012/19/EU**  
**WEEE**  
Waste Electrical &  
Electronic Equipment

**Directive 2014/30/EU**  
Electromagnetic Compatibility

# 1. Introduction

Is this chain saw compliant with EU Directives?

- ✓ • This guide is intended for quick evaluation of electric chain saw marking:
  - CE marking
  - Guaranteed sound power level
  
- ✓ • Documentation:
  - EU declaration of conformity (D.o.C.)
  - Instructions
  
- ✗ • This guide is not applicable for technical evaluations
- ✗ • This guide is not applicable to **battery powered chain saws for tree service**
- ✗ • This guide is not applicable to **combustion engine driven chain saws**
- ✗ • This guide contains extracts of relevant regulations and does not claim completeness of contents

## 2. Machinery Identification CE Marking

### Machinery Directive 2006/42/EC

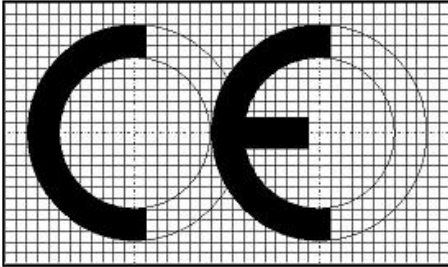

Illustration from 2006/42/EC

#### CE marking:



- The CE Conformity marking shall consist of the initials 'CE' as shown left;
- The CE marking shall be affixed to the machinery visibly, legibly and indelibly;
- The CE marking must include the minimum particulars (on the machine e.g. labelled, printed, embossed, etc.);
- The CE marking must be affixed in the immediate vicinity of the name of the manufacturer or his authorised representative, using the same technique.

#### Marking of machinery:

- Business name and address of the manufacturer and, where appointed, his authorised representative;
- Designation of the machinery (may be indicated by a code);
- Designation of series or type (may be indicated by a code and may be combined with the designation of the machinery);
- Serial number, if any;
- Year of construction/assembly.

# 3. Marking requirements

## From EN 62841-1:2015

- For mains powered chain saws:
  - Rated voltage or rated voltage range in Volts e.g. 230 V or 230-240 V
  - Nature of supply, e.g. 50 Hz or a.c. or ~
  - Symbol for class II machines 
  - Rated power input in Watts or rated current in Amperes
- For battery powered chain saws (voluntary marking):
  - Rated voltage in Volts e.g. 18 V
  - Nature of supply, d.c. or 

## From the WEEE Directive 2012/19/EU

- Waste Electrical & Electronic Equipment.



# 4. Marking / Outdoor Noise Label

## Outdoor Noise Directive 2000/14/EC (as amended)

- The indication of the guaranteed sound power level must consist of:
  - the single number of the guaranteed sound power in dB
  - the sign  $L_{WA}$  and
  - a pictogram taking the following form:

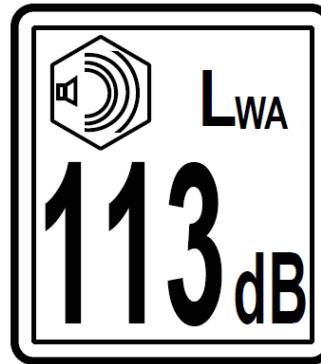

Example

- There are no noise limits for electric chain saws but the noise marking and the declaration of the values in the instructions are required.

# 5. Documentation / Instructions

## Machinery Directive 2006/42/EC

For clarification, consult the European Commission Guide to application of the Machinery Directive 2006/42/EC



- Machinery must be accompanied by instructions in the official Community language(s) of the Member State in which it is made available
- The instructions must contain at least the following information:
  - business name and full address of the manufacturer and, where appointed, his authorised representative;
  - descriptions and explanations necessary for safe use, adjustment and maintenance operations that should be carried out by the user, and preventive maintenance measures that should be taken;
  - a description of the intended use of the machinery;
  - warnings concerning ways in which the machinery must not be used that experience has shown might occur;
  - Noise emissions and hand-arm vibrations.



# 6. Documentation / EU Declaration of Conformity

**2006/42/EC, 2000/14/EC, 2014/30/EU, 2011/65/EU**

For clarification, consult the European Commission Guide to application of the Machinery Directive 2006/42/EC

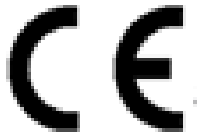

The EU declaration of conformity (D.o.C.) must contain at least the following particulars:

- business name and full address of the manufacturer and, where appropriate, his authorised representative;
- name and address of the person authorised to compile the technical file, who must be established in the European Union;
- description and identification of the machinery including generic denomination, function, model, type, serial number and commercial name;
- a sentence expressly declaring that the machinery fulfils all the relevant provisions of all applicable Directives;
- the name, address and notification number of the notified body which carried out the EC type examination in accordance with the Machinery Directive 2006/42/EC;
- the number of the EC type examination certificate;
- the guaranteed and measured sound power level in accordance with the Outdoor Noise Directive 2000/14/EC;
- the place and date of the declaration;
- the identity and signature of the person empowered to draw up the declaration on behalf of the manufacturer or his authorised representative.

# 7. Warning text or pictograms on the machine\*

- **WARNING – To reduce the risk of injury, user must read instructions or**



- **Wear eye protection or**



or



or



- **Wear ear protection (if applicable)**



- **Do not expose to rain or**



(if applicable)

- **Remove plug from the mains immediately if the cable is damaged or cut (if applicable)**



\* If pictograms are used, they must be explained in the instructions

\* If text is used, it must be in the official language(s) of the country where the product is sold